

CARTA IDROGRAFICA DELLA LAGUNA DI VENEZIA
versione 2023

Legenda

- edificato
- briccola
- briccola luminosa
- faro
- viabilità
- ferrovia
- fiume/canale
- chiaro
- ghebo
- barena ricostruita
- barena naturale
- barena naturalizzata
- sovrizzo
- velma
- stazione monitoraggio
- bilancia da pesca
- intervento P.I.O.P.
- protezione barene
- protezione isole minori
- Mose
- paratoie Mose
- conterminazione lagunare
- struttura nautica forte

PROVVEDITORATO INTERREGIONALE
PER LE OPERE PUBBLICHE
PER IL VENETO TRENTINO ALTO ADIGE
FRIULI VENEZIA GIULIA

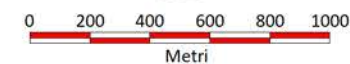

SISTEMA DI RIFERIMENTO
RDN 2008 - Fuso 12

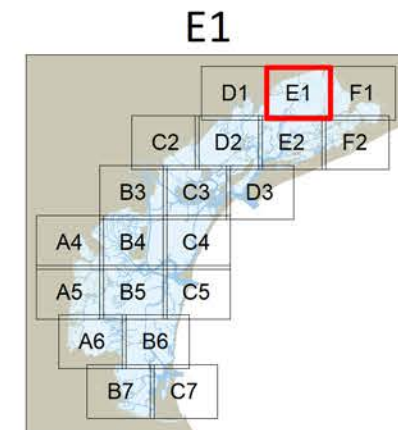
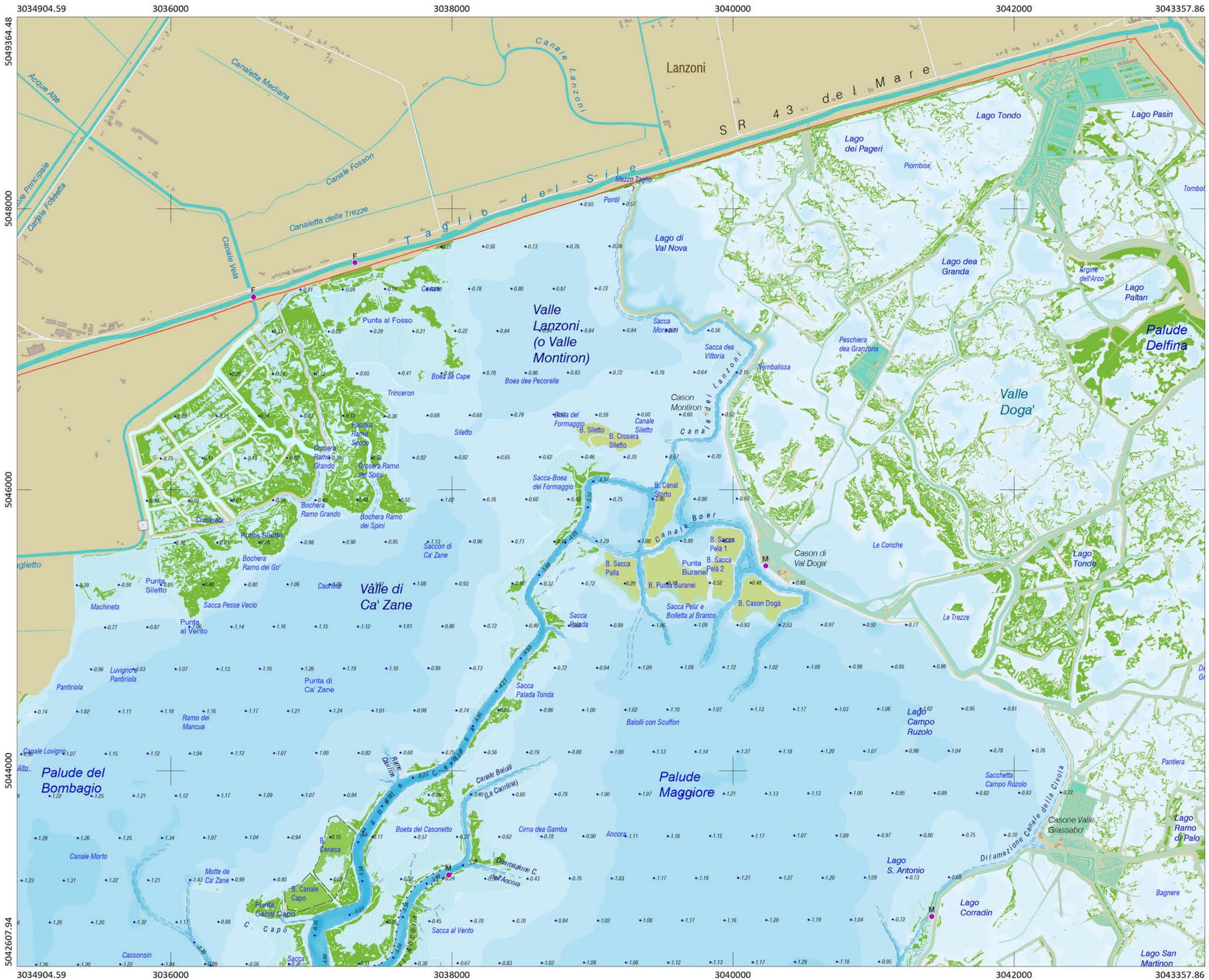

CARTA IDROGRAFICA DELLA LAGUNA DI VENEZIA
versione 2023

Legenda

- edificato
- briccola
- briccola luminosa
- faro
- viabilità
- ferrovia
- fiume/canale
- chiaro
- ghebo
- barena ricostruita
- barena naturale
- barena naturalizzata
- sovrizzo
- velma
- stazione monitoraggio
- bilancia da pesca
- intervento P.I.O.P.
- protezione barene
- protezione isole minori
- Mose
- paratoie Mose
- conterminazione lagunare
- struttura nautica
- forte

PROVVEDITORATO INTERREGIONALE
PER LE OPERE PUBBLICHE
PER IL VENETO TRENTINO ALTO ADIGE
FRIULI VENEZIA GIULIA

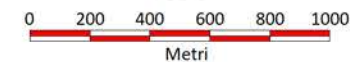

SISTEMA DI RIFERIMENTO
RDN 2008 - Fuso 12

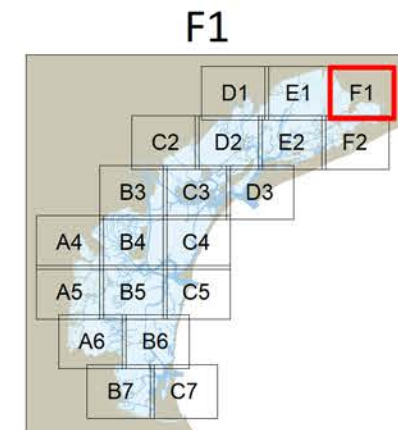

F1

**CARTA IDROGRAFICA
DELLA
LAGUNA DI VENEZIA**
versione 2023

Legenda

-  edificato
-  briccola
-  briccola luminosa
-  faro
-  viabilità
-  ferrovia
-  fiume/canale
-  chiaro
-  ghebo
-  barena ricostruita
-  barena naturale
-  barena naturalizzata
-  sovralzo
-  velma
-  stazione monitoraggio
-  bilancia da pesca
-  intervento P.I.O.P.
-  protezione barene
-  protezione isole minori
-  Mose
-  paratoie Mose
-  conterminazione lagunare
-  struttura nautica
-  forte

PROVVEDITORATO INTERREGIONALE
PER LE OPERE PUBBLICHE
PER IL VENETO TRENTINO ALTO ADIGE
FRIULI VENEZIA GIULIA



SISTEMA DI RIFERIMENTO
RDN 2008 - Fuso 12

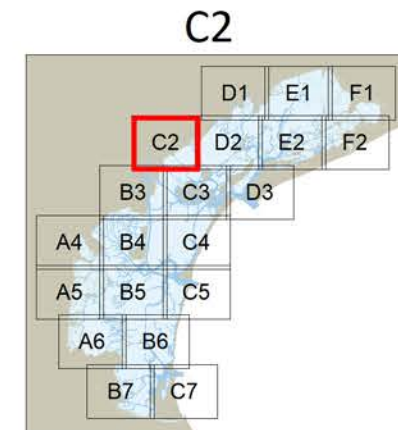

CARTA IDROGRAFICA DELLA LAGUNA DI VENEZIA
versione 2023

Legenda

- edificato
- briccola
- briccola luminosa
- faro
- viabilità
- ferrovia
- fiume/canale
- chiaro
- ghebo
- barena ricostruita
- barena naturale
- barena naturalizzata
- sovralzo
- velma
- stazione monitoraggio
- bilancia da pesca
- intervento P.I.O.P.
- protezione barene
- protezione isole minori
- Mose
- paratoie Mose
- conterminazione lagunare
- struttura nautica
- forte

PROVVEDITORATO INTERREGIONALE
PER LE OPERE PUBBLICHE
PER IL VENETO TRENTINO ALTO ADIGE
FRIULI VENEZIA GIULIA

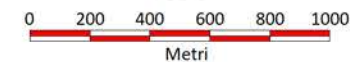

SISTEMA DI RIFERIMENTO
RDN 2008 - Fuso 12

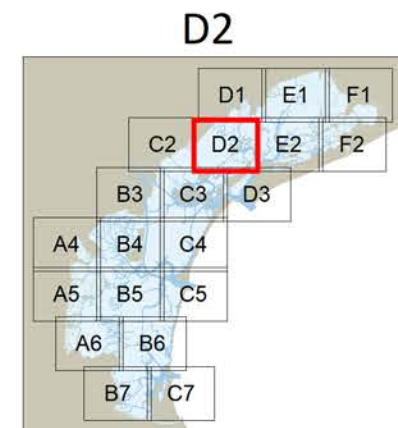
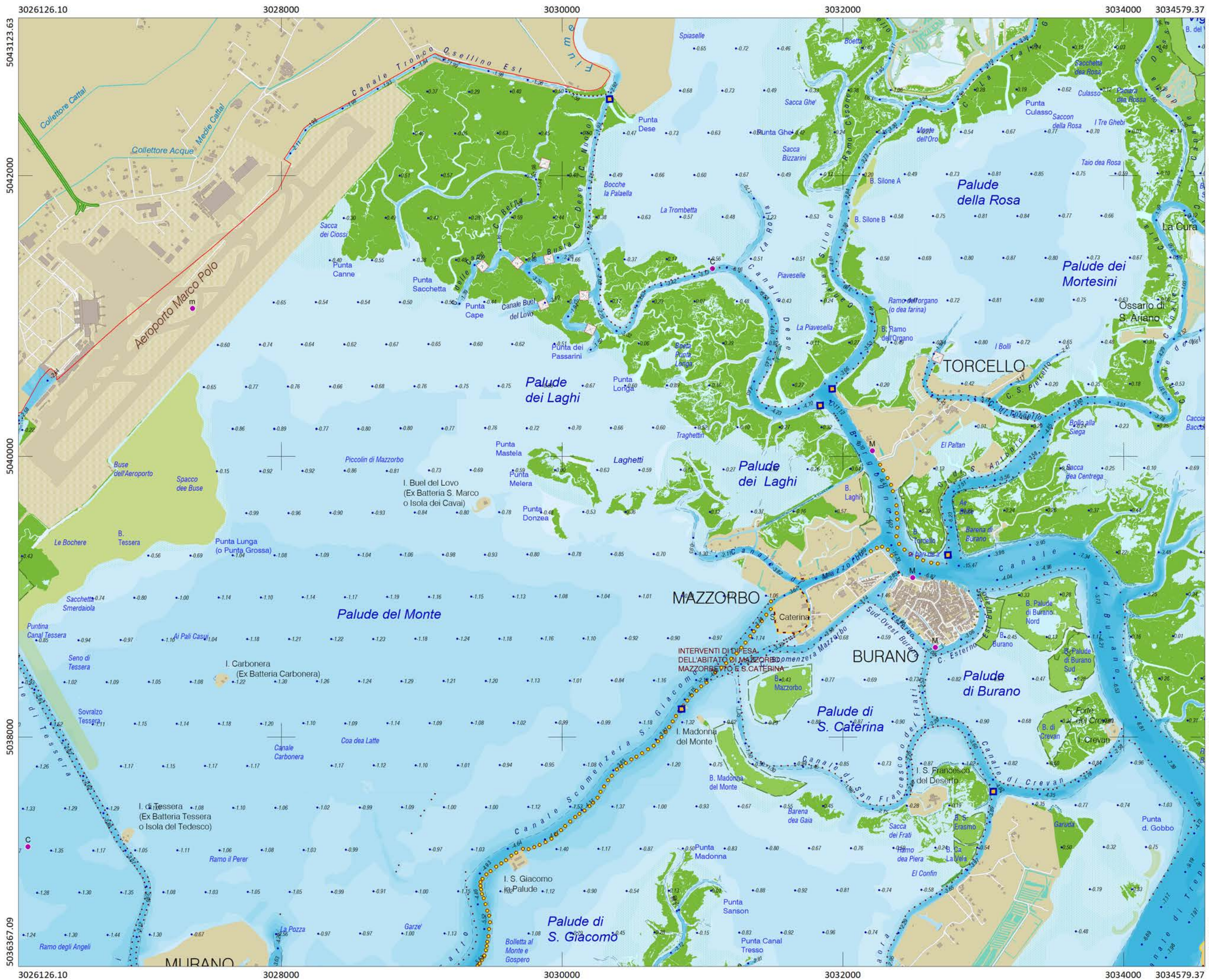

CARTA IDROGRAFICA DELLA LAGUNA DI VENEZIA
versione 2023

Legenda

- edificato
- briccola
- briccola luminosa
- faro
- viabilità
- ferrovia
- fiume/canale
- chiaro
- ghebo
- barena ricostruita
- barena naturale
- barena naturalizzata
- sovrizzo
- velma
- stazione monitoraggio
- bilancia da pesca
- intervento P.I.O.P.
- protezione barene
- protezione isole minori
- Mose
- paratoie Mose
- conterminazione lagunare
- struttura nautica
- forte

PROVVEDITORATO INTERREGIONALE
PER LE OPERE PUBBLICHE
PER IL VENETO TRENTINO ALTO ADIGE
FRIULI VENEZIA GIULIA



SISTEMA DI RIFERIMENTO
RDN 2008 - Fuso 12

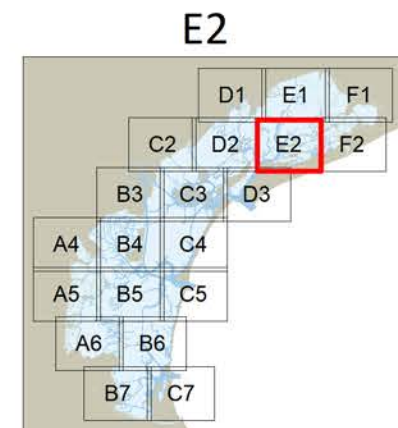

CARTA IDROGRAFICA DELLA LAGUNA DI VENEZIA
versione 2023

Legenda

- edificato
- briccola
- briccola luminosa
- faro
- viabilità
- ferrovia
- fiume/canale
- chiaro
- ghebo
- barena ricostruita
- barena naturale
- barena naturalizzata
- sovralzo
- velma
- stazione monitoraggio
- bilancia da pesca
- intervento P.I.O.P.
- protezione barene
- protezione isole minori
- Mose
- paratoie Mose
- conterminazione lagunare
- struttura nautica
- forte

PROVVEDITORATO INTERREGIONALE
PER LE OPERE PUBBLICHE
PER IL VENETO TRENTINO ALTO ADIGE
FRIULI VENEZIA GIULIA



SISTEMA DI RIFERIMENTO
RDN 2008 - Fuso 12

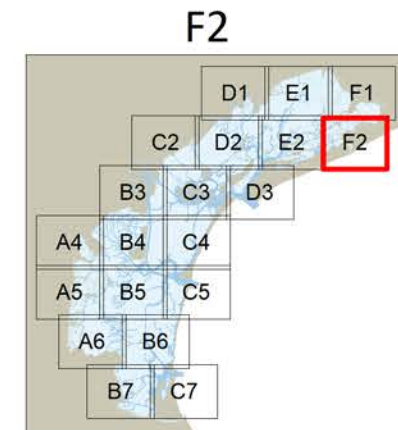

F2

**CARTA IDROGRAFICA
DELLA
LAGUNA DI VENEZIA**
versione 2023

Legenda

-  edificato
-  briccola
-  briccola luminosa
-  faro
-  viabilità
-  ferrovia
-  fiume/canale
-  chiaro
-  ghebo
-  barena ricostruita
-  barena naturale
-  barena naturalizzata
-  sovralzo
-  velma
-  stazione monitoraggio
-  bilancia da pesca
-  intervento P.I.O.P.
-  protezione barene
-  protezione isole minori
-  Mose
-  paratoie Mose
-  conterminazione lagunare
-  struttura nautica
-  forte

PROVVEDITORATO INTERREGIONALE
PER LE OPERE PUBBLICHE
PER IL VENETO TRENTO ALTO ADIGE
FRIULI VENEZIA GIULIA



SISTEMA DI RIFERIMENTO
RDN 2008 - Fuso 12

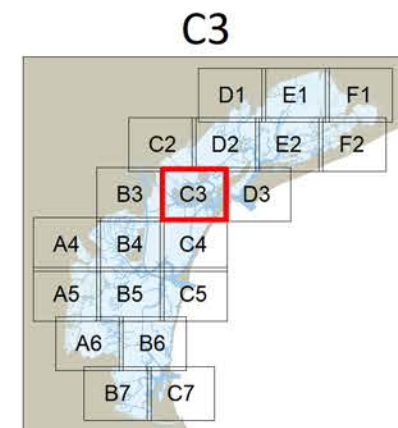
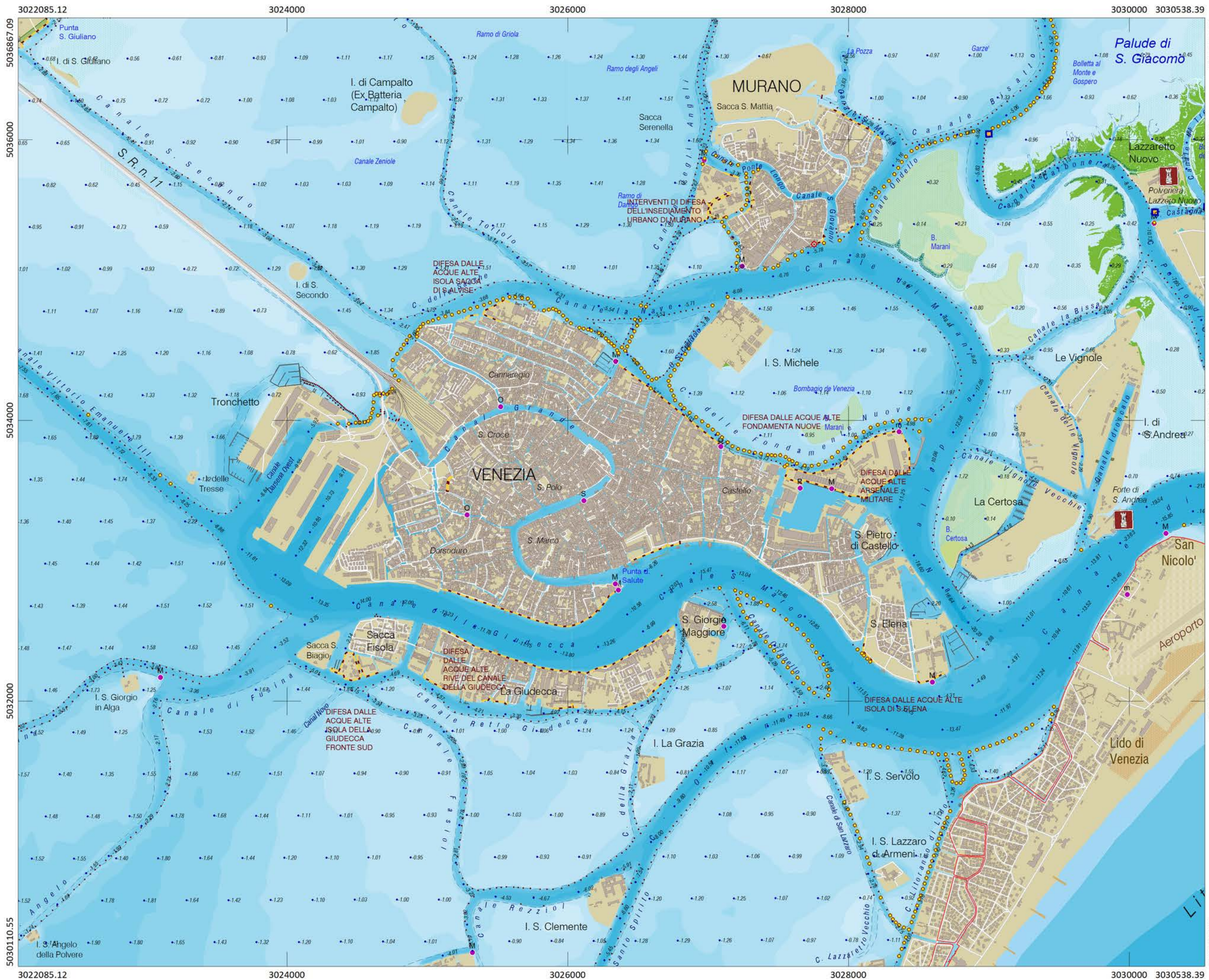

CARTA IDROGRAFICA DELLA LAGUNA DI VENEZIA
versione 2023

Legenda

- edificato
- briccola
- briccola luminosa
- faro
- viabilità
- ferrovia
- fiume/canale
- chiaro
- ghebo
- barena ricostruita
- barena naturale
- barena naturalizzata
- sovralzo
- velma
- stazione monitoraggio
- bilancia da pesca
- intervento P.I.O.P.
- protezione barene
- protezione isole minori
- Mose
- paratoie Mose
- conterminazione lagunare
- struttura nautica
- forte

PROVVEDITORATO INTERREGIONALE
PER LE OPERE PUBBLICHE
PER IL VENETO TRENTINO ALTO ADIGE
FRIULI VENEZIA GIULIA



SISTEMA DI RIFERIMENTO
RDN 2008 - Fuso 12

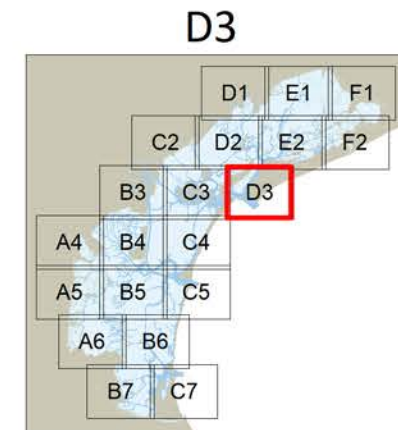

CARTA IDROGRAFICA DELLA LAGUNA DI VENEZIA
versione 2023

Legenda

- edificato
- briccola
- briccola luminosa
- faro
- viabilità
- ferrovia
- fiume/canale
- chiaro
- ghebo
- barena ricostruita
- barena naturale
- barena naturalizzata
- sovrizzo
- velma
- stazione monitoraggio
- bilancia da pesca
- intervento P.I.O.P.
- protezione barene
- protezione isole minori
- Mose
- paratoie Mose
- conterminazione lagunare
- struttura nautica
- forte

PROVVEDITORATO INTERREGIONALE
PER LE OPERE PUBBLICHE
PER IL VENETO TRENTINO ALTO ADIGE
FRIULI VENEZIA GIULIA

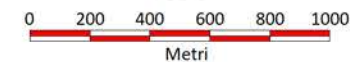

SISTEMA DI RIFERIMENTO
RDN 2008 - Fuso 12

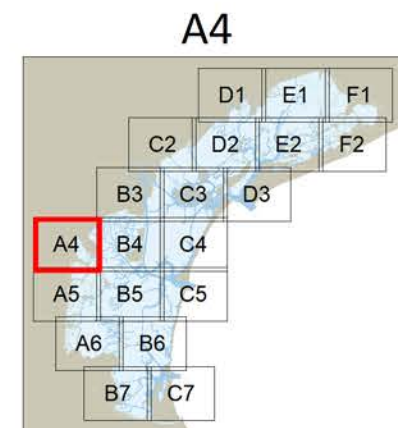

CARTA IDROGRAFICA DELLA LAGUNA DI VENEZIA
versione 2023

Legenda

- edificato
- briccola
- briccola luminosa
- faro
- viabilità
- ferrovia
- fiume/canale
- chiaro
- ghebo
- barena ricostruita
- barena naturale
- barena naturalizzata
- sovrizzo
- velma
- stazione monitoraggio
- bilancia da pesca
- intervento P.I.O.P.
- protezione barene
- protezione isole minori
- Mose
- paratoie Mose
- conterminazione lagunare
- struttura nautica forte

PROVVEDITORATO INTERREGIONALE
PER LE OPERE PUBBLICHE
PER IL VENETO TRENTO ALTO ADIGE
FRIULI VENEZIA GIULIA



SISTEMA DI RIFERIMENTO
RDN 2008 - Fuso 12

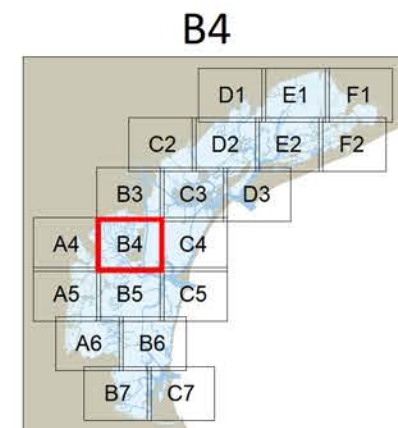

CARTA IDROGRAFICA DELLA LAGUNA DI VENEZIA
versione 2023

Legenda

- edificato
- bricola
- bricola luminosa
- faro
- viabilità
- ferrovia
- fiume/canale
- chiaro
- ghebo
- barena ricostruita
- barena naturale
- barena naturalizzata
- sovrizzo
- velma
- stazione monitoraggio
- bilancia da pesca
- intervento P.I.O.P.
- protezione barene
- protezione isole minori
- Mose
- paratoie Mose
- conterminazione lagunare
- struttura nautica
- forte

PROVVEDITORATO INTERREGIONALE
PER LE OPERE PUBBLICHE
PER IL VENETO TRENTO ALTO ADIGE
FRIULI VENEZIA GIULIA



SISTEMA DI RIFERIMENTO
RDN 2008 - Fuso 12

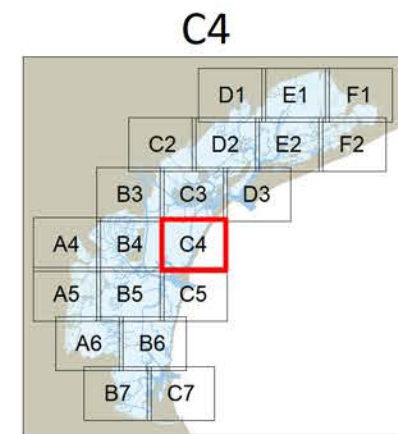
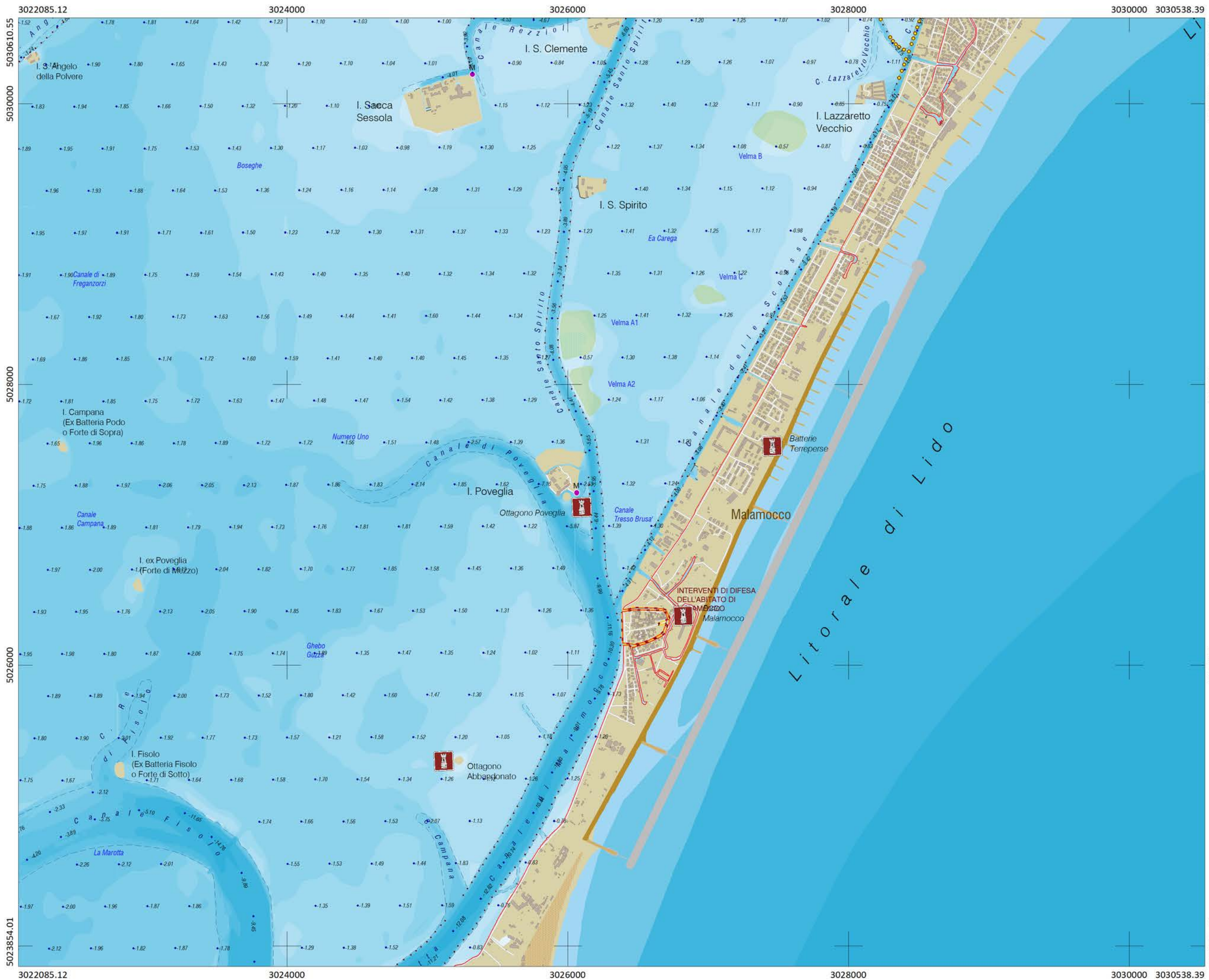

CARTA IDROGRAFICA DELLA LAGUNA DI VENEZIA
versione 2023

Legenda

-  edificato
-  briccola
-  briccola luminosa
-  faro
-  viabilità
-  ferrovia
-  fiume/canale
-  chiaro
-  ghebo
-  barena ricostruita
-  barena naturale
-  barena naturalizzata
-  sovralzo
-  velma
-  stazione monitoraggio
-  bilancia da pesca
-  intervento P.I.O.P.
-  protezione barene
-  protezione isole minori
-  Mose
-  paratoie Mose
-  conterminazione lagunare
-  struttura nautica
-  forte

PROVVEDITORATO INTERREGIONALE
PER LE OPERE PUBBLICHE
PER IL VENETO TRENTINO ALTO ADIGE
FRIULI VENEZIA GIULIA



SISTEMA DI RIFERIMENTO
RDN 2008 - Fuso 12

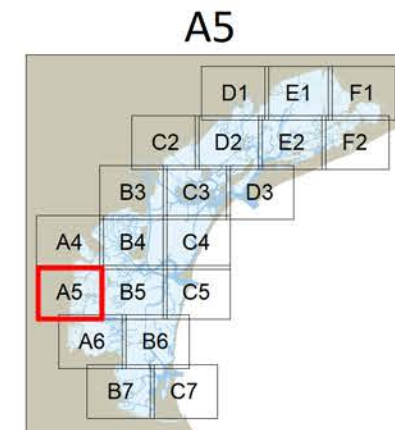

CARTA IDROGRAFICA DELLA LAGUNA DI VENEZIA
versione 2023

Legenda

- edificato
- briccola
- briccola luminosa
- faro
- viabilità
- ferrovia
- fiume/canale
- chiaro
- ghebo
- barena ricostruita
- barena naturale
- barena naturalizzata
- sovralzo
- velma
- stazione monitoraggio
- bilancia da pesca
- intervento P.I.O.P.
- protezione barene
- protezione isole minori
- Mose
- paratoie Mose
- conterminazione lagunare
- struttura nautica forte

PROVVEDITORATO INTERREGIONALE
PER LE OPERE PUBBLICHE
PER IL VENETO TRENTINO ALTO ADIGE
FRIULI VENEZIA GIULIA

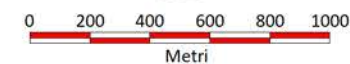

SISTEMA DI RIFERIMENTO
RDN 2008 - Fuso 12

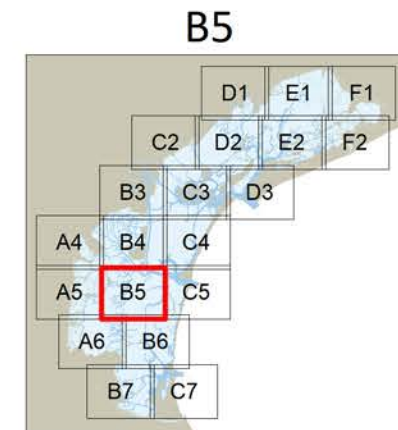
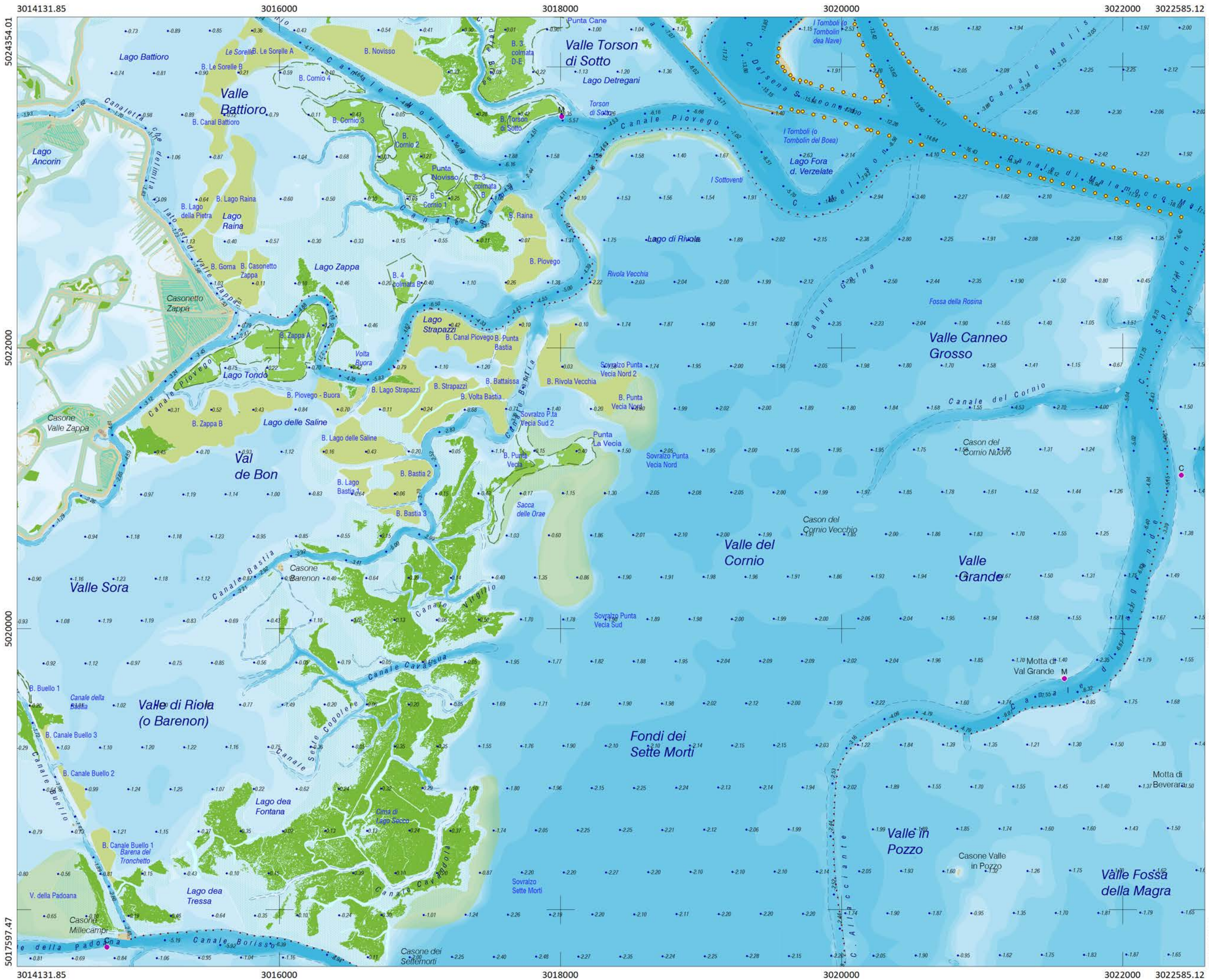

CARTA IDROGRAFICA DELLA LAGUNA DI VENEZIA
versione 2023

Legenda

-  edificato
-  briccola
-  briccola luminosa
-  faro
-  viabilità
-  ferrovia
-  fiume/canale
-  chiaro
-  barena ricostruita
-  barena naturale
-  barena naturalizzata
-  sovrizzo
-  velma
-  stazione monitoraggio
-  bilancia da pesca
-  intervento P.I.O.P.
-  protezione barene
-  protezione isole minori
-  Mose
-  paratoie Mose
-  conterminazione
-  struttura lagunare
-  forte

PROVVEDITORATO INTERREGIONALE
PER LE OPERE PUBBLICHE
PER IL VENETO TRENTINO ALTO ADIGE
FRIULI VENEZIA GIULIA

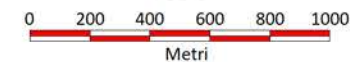

SISTEMA DI RIFERIMENTO
RDN 2008 - Fuso 12

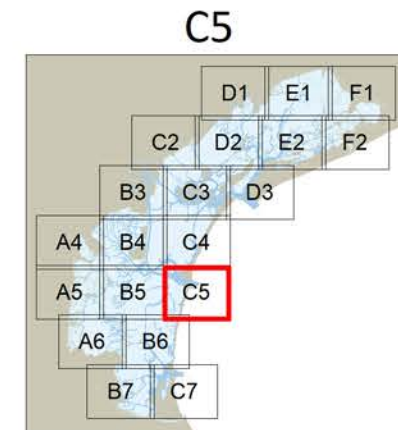
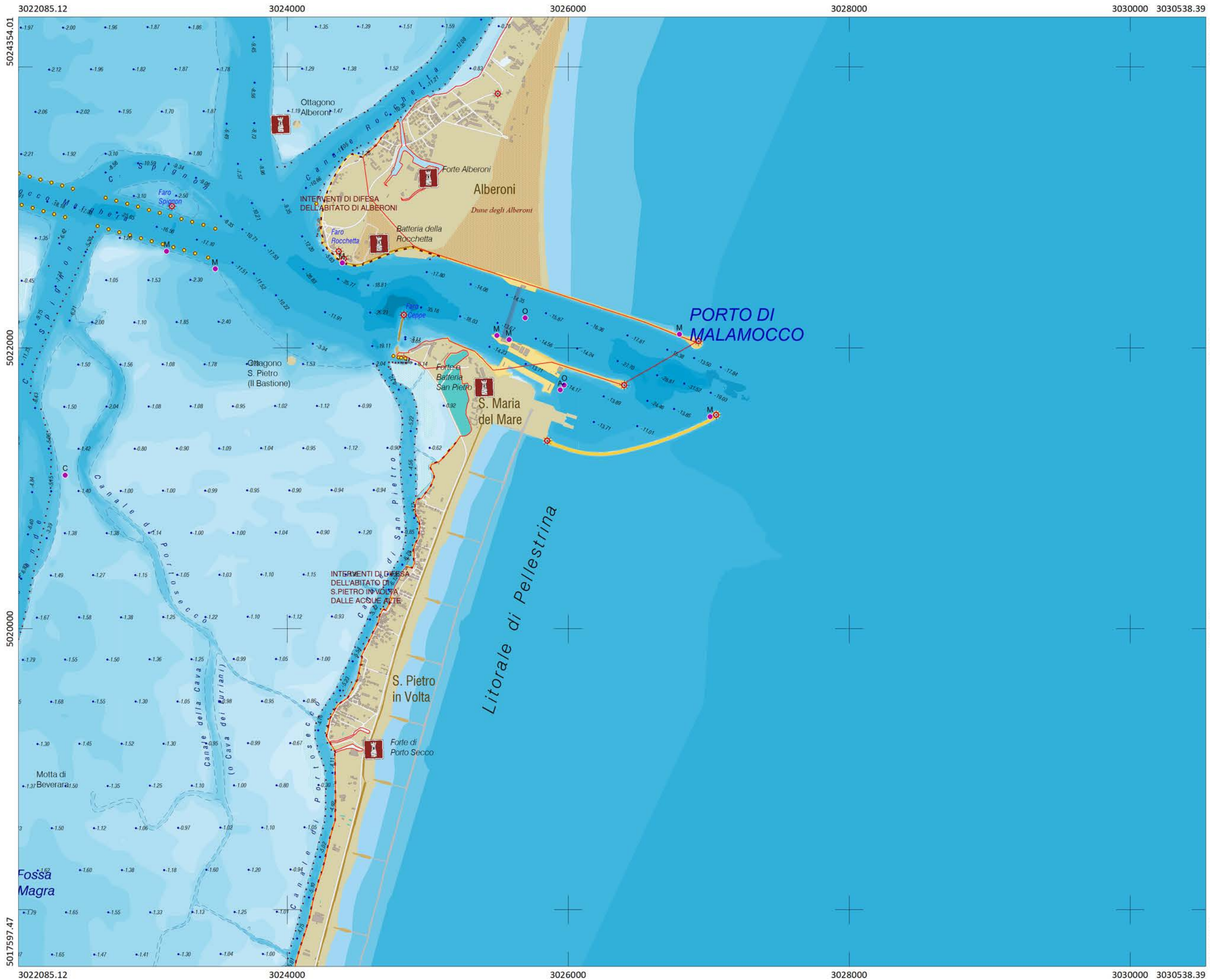

CARTA IDROGRAFICA DELLA LAGUNA DI VENEZIA
versione 2023

Legenda

- edificato
- briccola
- briccola luminosa
- faro
- viabilità
- ferrovia
- fiume/canale
- chiaro
- ghebo
- barena ricostruita
- barena naturale
- barena naturalizzata
- sovrizzo
- velma
- stazione monitoraggio
- bilancia da pesca
- intervento P.I.O.P.
- protezione barene
- protezione isole minori
- Mose
- paratoie Mose
- conterminazione lagunare
- struttura nautica
- forte

PROVVEDITORATO INTERREGIONALE
PER LE OPERE PUBBLICHE
PER IL VENETO TRENTINO ALTO ADIGE
FRIULI VENEZIA GIULIA

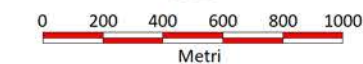

SISTEMA DI RIFERIMENTO
RDN 2008 - Fuso 12

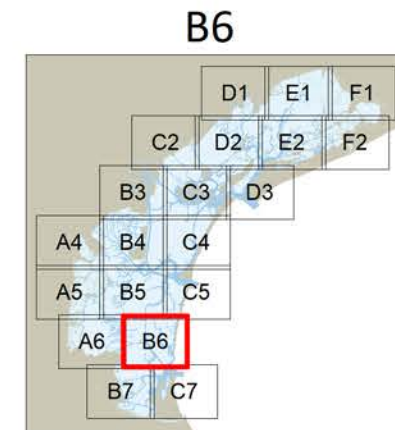
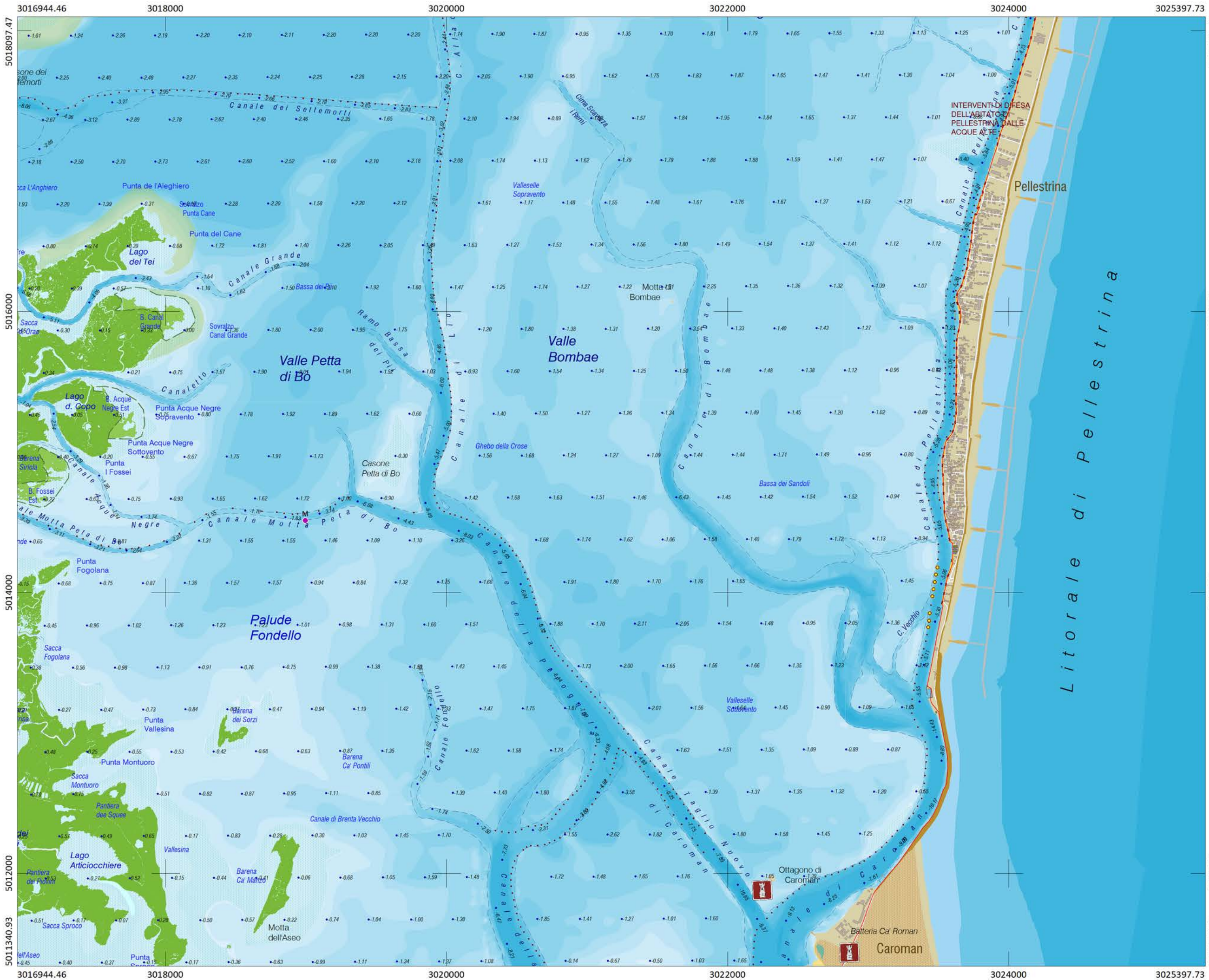

CARTA IDROGRAFICA DELLA LAGUNA DI VENEZIA
versione 2023

Legenda

-  edificato
-  bricola
-  bricola luminosa
-  faro
-  viabilità
-  ferrovia
-  fiume/canale
-  chiaro
-  ghebo
-  barena ricostruita
-  barena naturale
-  barena naturalizzata
-  sovralzo
-  velma
-  stazione monitoraggio
-  bilancia da pesca
-  intervento P.I.O.P.
-  protezione barene
-  protezione isole minori
-  Mose
-  paratoie Mose
-  conterminazione lagunare
-  struttura nautica forte

PROVVEDITORATO INTERREGIONALE
PER LE OPERE PUBBLICHE
PER IL VENETO TRENTINO ALTO ADIGE
FRIULI VENEZIA GIULIA

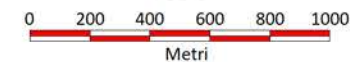

SISTEMA DI RIFERIMENTO
RDN 2008 - Fuso 12

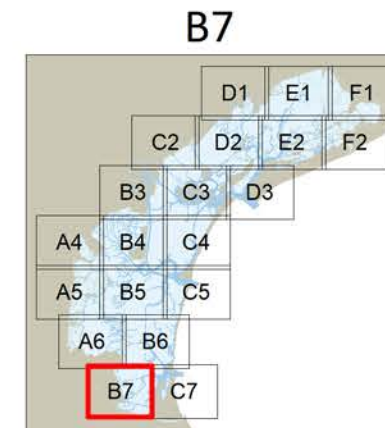
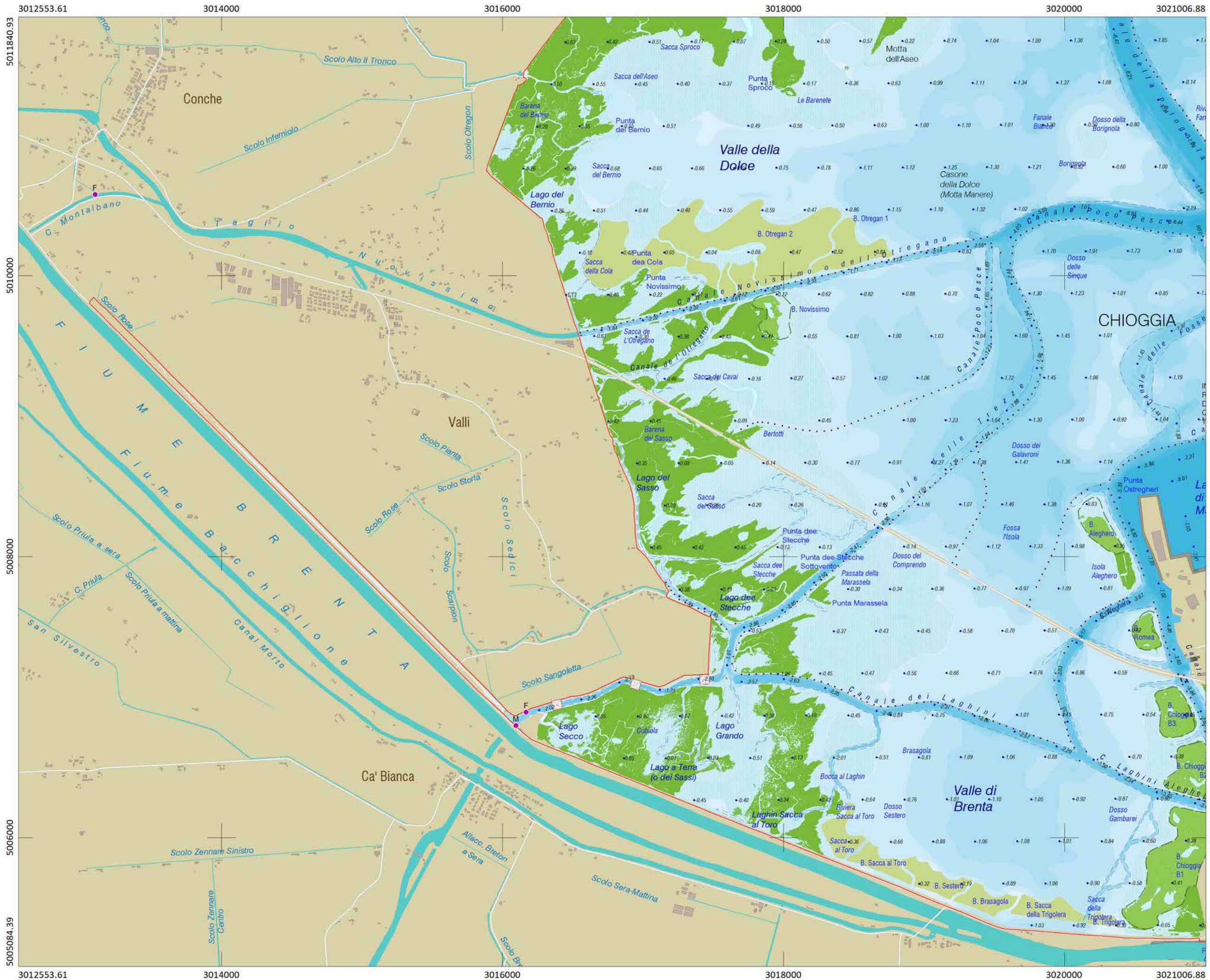

CARTA IDROGRAFICA DELLA LAGUNA DI VENEZIA
versione 2023

Legenda

-  edificato
-  briccola
-  briccola luminosa
-  faro
-  viabilità
-  ferrovia
-  fiume/canale
-  chiaro
-  ghebo
-  barena ricostruita
-  barena naturale
-  barena naturalizzata
-  sovrizzo
-  velma
-  stazione monitoraggio
-  bilancia da pesca
-  intervento P.I.O.P.
-  protezione barene
-  protezione isole minori
-  Mose
-  paratoie Mose
-  conterminazione lagunare
-  struttura nautica
-  forte

PROVVEDITORATO INTERREGIONALE
PER LE OPERE PUBBLICHE
PER IL VENETO TRENTINO ALTO ADIGE
FRIULI VENEZIA GIULIA

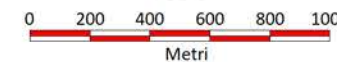

SISTEMA DI RIFERIMENTO
RDN 2008 - Fuso 12

